

ACTIVE VIBRATION ISOLATION SYSTEM *TS-150LP / TS-140LP / TS-300LP*

Instruction Manual



The TableStable Ltd.
Im Grindel 6
8932 Mettmenstetten
Switzerland

Phone: +41 (0)44 776 33 66
Fax: +41 (0)44 776 33 65
E-mail: info@tablestable.com
Internet: www.tablestable.com

Vibration Isolation Technology made in Switzerland



Table of Contents

<i>General</i>	3
<i>Notes on Equipment Safety</i>	4
<i>Safety Instructions</i>	4
<i>Cleaning the Outside of the System</i>	4
<i>Accessories</i>	4
<i>Optimum Support Surface</i>	6
<i>Test of Support Surface</i>	6
<i>System Setup</i>	6
<i>Front Panel and Display Overview</i>	7
<i>Function Menu</i>	9
<i>Isolation Mode</i>	10
<i>BNC Diagnostic Output</i>	10
<i>Locking System for Transport</i>	10
<i>Optional Accessories</i>	11
<i>Fuses</i>	11
<i>Specifications TS-150LP, TS-140LP, TS-300LP</i>	12
<i>Bottom Mounting Holes</i>	13
<i>Transmissibility</i>	14
<i>Service Order</i>	15
<i>Sales Offices</i>	15

Thank you...

...for your purchase of the **TS active vibration isolation system**. This system has been designed specifically with performance and ease of use in mind. As with all TableStable products, this system is made to the highest quality standards using precision electronics and mechanical components which should give you many years of trouble free use. Please read this instruction manual carefully before use to ensure you get the best out of your new isolation system.

General

The TS-series are compact dynamic antivibration systems, which offer isolation against all six translational and rotational vibration modes.

These moderately priced dynamic vibration isolation systems achieve in a very small volume better isolation than is possible with the biggest and most expensive passive systems. Inertial feedback using piezoelectric force motors provides not only isolation from building vibrations, but also isolation from vibration sources placed on the system itself. This means, for example, that a delicate microscope isolated by the system will remain at rest despite forces being applied via the operator's hands.

The inherent stiffness of the systems, some 200 - 500 times greater than that of a 1 Hz resonance passive isolator, imparts excellent directional and positional stability.

The characteristics of an active isolation system are typified by the virtual lack of any low frequency resonance, a resonance which plagues all passive isolation systems.

The systems have been designed to offer excellent isolation even at frequencies as low as 2-3Hz, where many buildings show large horizontal amplitudes due to oscillation about the vertical axis. Isolation begins at about 0.7 Hz, increasing rapidly to at least 40dB beyond about 10Hz.

These systems are extremely convenient to use. Load compensation (auto-levelling) is performed automatically on switching on the power. If the load is changed whilst the system is isolating, it automatically readjusts and then returns to the isolation mode. Furthermore, at the push of a button the system locks itself for shipping. Apart from a single adjustable foot to allow for unevenness in the support surface, there are no manual adjustments to be made.

All the control circuitry, including the power supply, is built into the unit. Power consumption is less than 10 W. The unit has a universal input and may be connected to any AC power point from 90 to 120VAC, or 200 to 240VAC

The design has been optimized to achieve best possible isolation for delicate instruments such as the Scanning Probe Microscopes (AFM, STM), Scanning Electron Microscopes, Interferometers and other high resolution instruments, allowing the ultimate performance to be achieved from these instruments. The tables have also proved to be extremely successful for supporting sensitive experiments, such as patch clamp, micro injection or the troughs for liquids used in measurements on Langmuir-Blodgett films.

Notes on Equipment Safety

The vibration isolation systems **TS-150**, **TS-140**, **TS-300** have been designed, manufactured and tested to conform to the safety regulations for measurement- and control-equipment DIN EN 61010-1:2001 (IEC 61010-1 second edition 2001-02) and satisfy the relevant requirements of EEC Directive 73/23. The systems conform to EEC Directive 89/336 (electro-magnetic compatibility).

Safety Instructions

- The system may only be plugged into a socket with separate ground. Do not disconnect this ground, either at the socket, or by using an ungrounded extension cable.
- Before switching on this apparatus make sure that it is connected to the correct mains voltage.
- Do not remove any cover or allow any metal objects to enter any openings in the unit.
- Do not disassemble or attempt to repair the system. This may result in electric shock or damage to the system.
- Disconnect from mains before removing any covers. Refer servicing to qualified personnel.
- Do not use in potentially explosive surroundings.
- Do not drill any holes into the top plate. This will damage the system.
- If you suspect the system to be in any way unsafe, unplug and prevent any possible accidental usage. Contact your nearest service centre.

Cleaning the Outside of the System

Use neutral detergents. Cleaning with solvents will damage the outside surface of the system. DO NOT use cleaning materials that contain ammonia. DO NOT use isopropyl alcohol to remove dirt from the control panel. It may crack the panel. DO NOT use flammable substances or any type of spray to clean the system.

Accessories

- 1 Power Cable
- 1 Manual

Correction Amplitude

The systems offer excellent isolation in the typical laboratory environment. The maximum vibration amplitude that can be compensated is frequency dependent, reflecting the fact that in typical environments the amplitudes decrease rapidly at higher frequencies. Up to 20Hz **amplitudes** of 20 μm can be compensated in all directions. At higher frequencies the maximum correction amplitude decreases inversely proportional to frequency (see diagram), corresponding to a maximum correction **velocity** of 2.5mm/s.

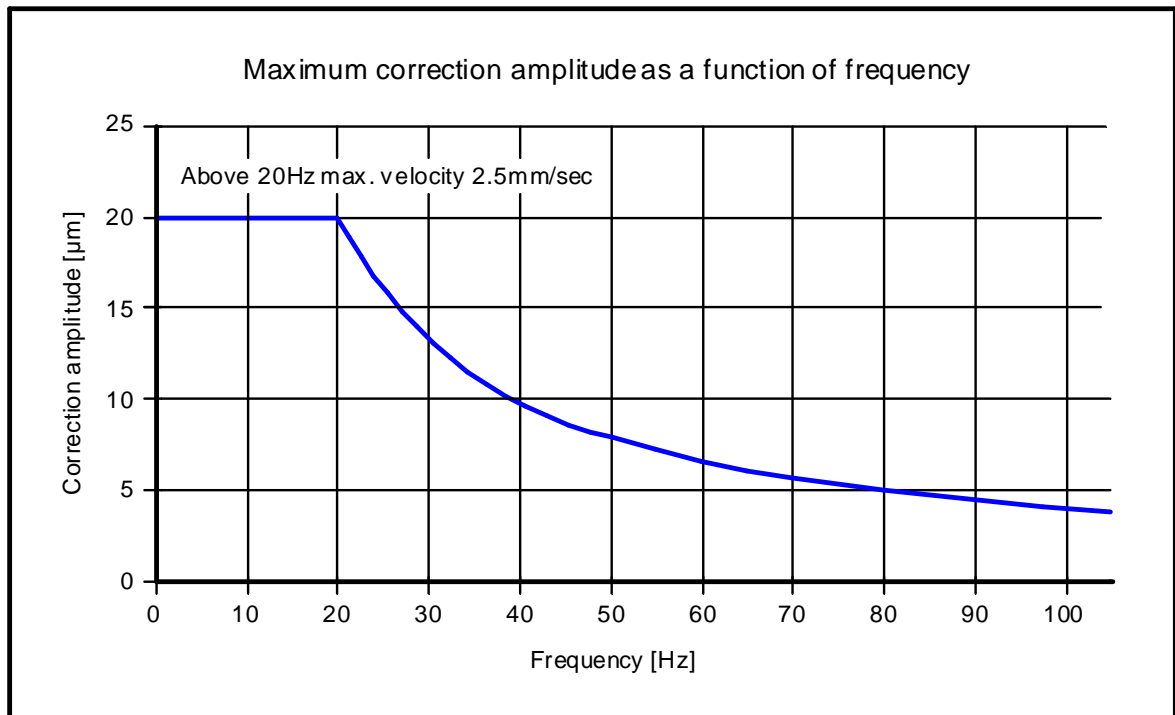

Note: At frequencies around 0.5Hz, even though there is no isolation at these frequencies, the system will be driven into saturation by amplitudes of around 10 μm . This will not normally be a problem unless you are working at the top of a very tall building.

Optimum Support Surface

To obtain the optimum performance from the system it must be supported on a surface which is as rigid as possible. The best possible performance is obtained with the system sitting directly on the floor. However for most applications this will not be practical, and some support structure will be required to bring the system to a convenient operating height. Most simple table structures will be rigid enough vertically, but will leave much to be desired horizontally. The addition of diagonal struts between the table legs can improve the situation dramatically.

It is good to bear in mind that any support structure will follow the building vibrations exactly up to some certain cut off frequency at which point the structure goes into resonance and amplifies the vibration amplitudes. A typical structure may have its lowest horizontal resonance frequencies around 40-60 Hz.

It is an unfortunate fact of life that the amplitudes of the vertical vibrations of the building (dominantly bending modes of the floor) are largest in the centre of the floor, where for convenience most experiments are situated!

Since the system is quite small, a possible location may be on a shelf attached to a building pillar. Good braces will be required to support the shelf. This location has the advantage that the vertical vibrations of the building will be very much reduced.

Test of Support Surface

Although the systems will operate on virtually any support surface, a soft support structure resonantly amplifies certain building vibration frequencies and these will therefore be less effectively isolated.

You can obtain an idea for the suitability of your support structure by observing the diagnostic signal while pushing on the support. The isolation should be disabled for this test. If the support is rigid the signals should hardly respond to a push on the support in any direction. Now try tapping the support to excite its internal resonances. Generally the support will react more strongly to a horizontal tap than to a vertical one. A very resonant support will show long lived resonances and the isolation will be seriously affected at these frequencies. A better support will show well damped resonances.

System Setup

For shipping the system has been locked to prevent damage.

It will automatically be unlocked when power is applied to the system. Sometimes equipment can get very cold during shipping. We recommend that if the system is cold you allow 2-3 hours for it to reach room temperature before connecting the power, otherwise a malfunction may arise due to condensation.

Auto-Levelling

When operating the system for the first time, place on a suitable rigid support surface and switch on the power. If the system has been locked for transport the motors will run rapidly for a few seconds until the system is floating.

Adjustable Foot



Important: make sure that the system is unlocked before adjusting the foot

Before proceeding check first that the system is sitting properly on the support surface.
The rear right foot is adjustable – turn until the system is sitting well balanced on all four feet.



Front Panel and Display Overview

TS Front panel

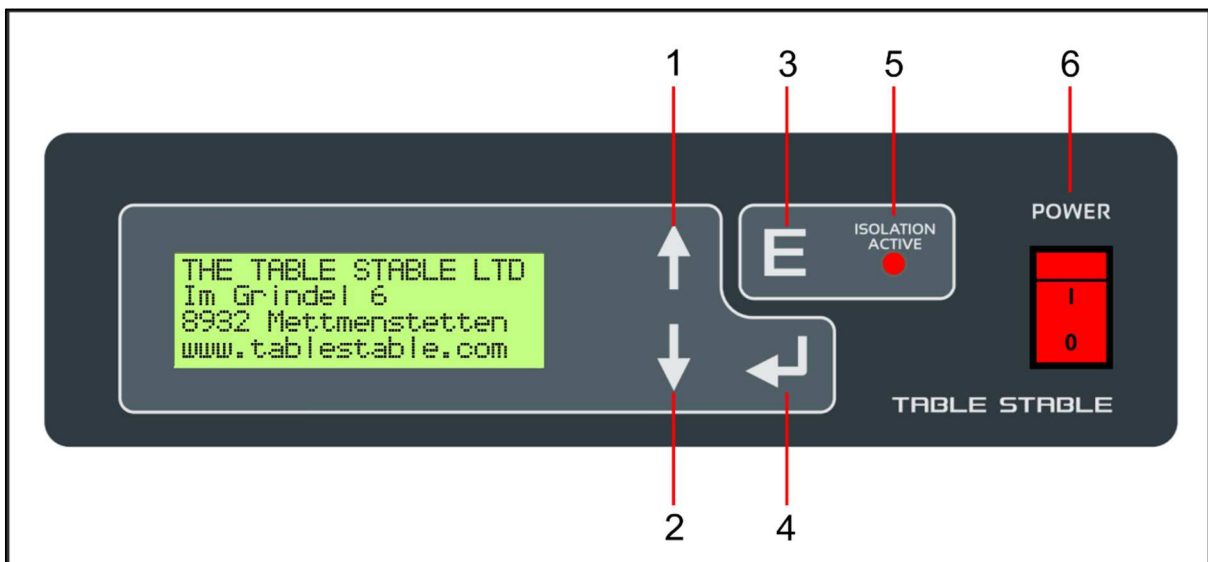

- | | | | |
|---|----------------------------|---|---------------------|
| 1 | Scroll up | 4 | Enter |
| 2 | Scroll down | 5 | Isolation Indicator |
| 3 | Enable / Disable Isolation | 6 | Power switch |

Display Overview

Push **↑** or **↓** to toggle between display pages:

```
***** TS-150 *****
HEIGHT ADJUSTMENT
```

System is setting the correct height.

```
***** TS-150 *****
HEIGHT ADJUST ERROR
```

System is unable to set the correct height.
The load may be badly distributed.

```
***** TS-150 *****
ISOLATION DISABLED
```

Isolation off, push **E** to activate isolation.

```
***** TS-150 *****
ISOLATION ENABLED
```

System is isolating, push **E** to deactivate isolation.

```
SYSTEM UNLOCKED
PUSH ↵ TO LOCK
```

Push **↓** to lock the system for transport.
System will automatically unlock when the power is switched on again.

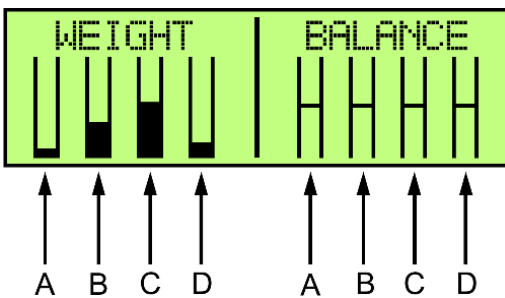

Balance

Shows the centre of the height adjustment. Under normal circumstances the bars should be approximately in the middle. A flashing bar means the system is not balanced and will not isolate.

Weight

Shows the load on each corner. A flashing bar means an overload or bad load distribution, the system will not isolate.

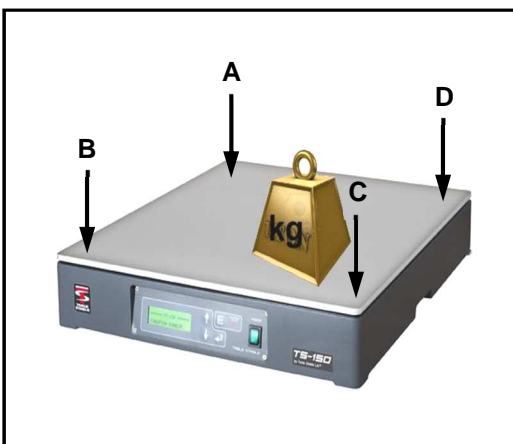

Example:

Load is sitting towards the right front corner.
Display shows bar "C" higher than the others.

Function Menu

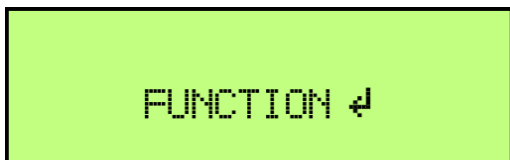

Push \rightarrow to gain access to the function menu.



The backlight may be turned off if desired. Scroll display to the appropriate function and push \rightarrow to toggle between backlight on and off.

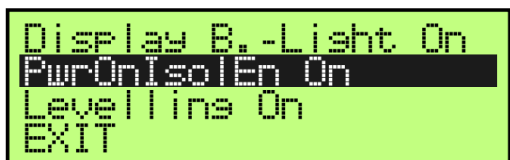

Power-on isolation enable
If this function is on, the isolation will start automatically after the system is switched on. This function is useful when a remote control-box is connected on the rear (Optional).



Levelling on/off
If this function is on, the system will adjust the height automatically depending on the load. Levelling off will disable all levelling motors.

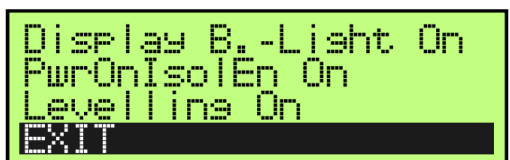

Push \rightarrow to exit the function menu without saving the changes. When you switch the system off, all settings will be lost.

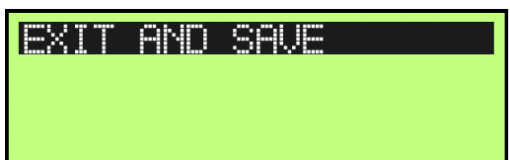

Push \rightarrow to exit the function menu and save all the settings. All settings will be present after switching the system off.

Observing Mode

Time Base N (0-4)

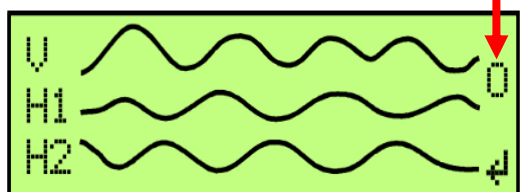

On using the system for the first time it is strongly recommended that you observe this signal, with the isolation both **Enabled** and **Off** - it gives a good impression of how well the system is operating.

The traces show velocity, but are not calibrated. The top trace is vertical and the lower 2 traces show *the horizontal* vibrations.

H1 is parallel to the **short side** of the unit
H2 is parallel to the **long side**

The time axis can be changed by pushing the **Enter** button. A higher index number N gives a slower display. The approximate time per scan is 160×2^N milliseconds.

Note: This function is not intended for measurement purposes and is not calibrated.

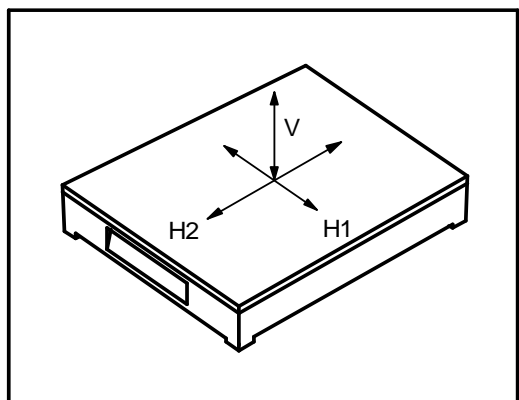

Isolation Mode

After switching on the power, and once the motors have stopped running, the table top will be floating and the display will show "Isolation Disabled".

To enable the isolation merely push the button marked **E**.
The system is now operating and the red LED will light up.

BNC Diagnostic Output

The rear panel BNC socket gives a multiplexed output showing the signals from all 8 accelerometers. **V1-V4** are the vertical axes, **H1-H4** are the horizontal axes.

To view this signal on an oscilloscope, set the time base to **20ms** and the sensitivity to **0.2V**.

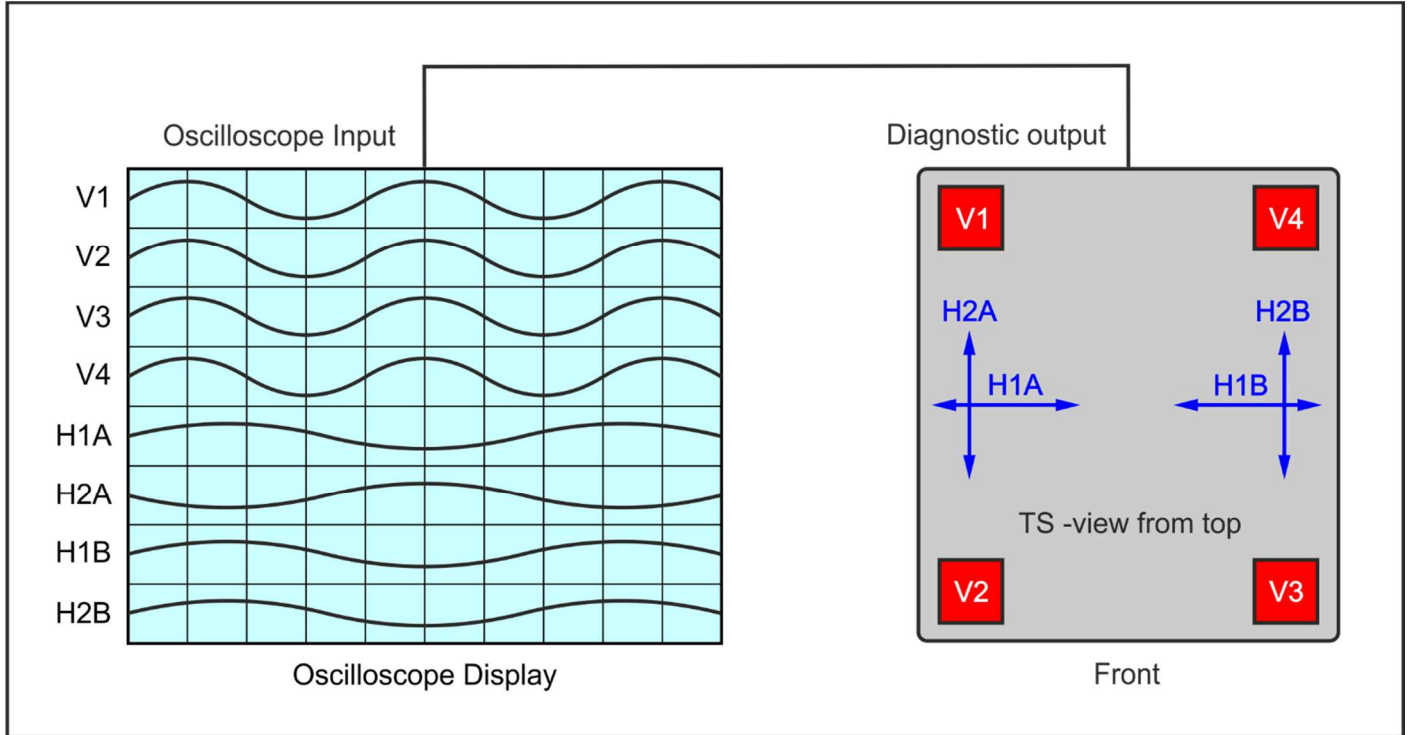

Note: The signals are for diagnostic purposes only and are not calibrated.

Locking System for Transport



In order to prevent damage during shipping it is essential to lock the system.

SYSTEM UNLOCKED
PUSH ↙ TO LOCK

With the system switched on, scroll the display until the message "PUSH ↙ TO LOCK" appears.

Push ↙ and the motors will run, gradually slow down and then stop. The message "SYSTEM LOCKED" will appear.
Then switch off the power.

The next time the system is powered up it will automatically unlock.

Optional Accessories

Remote control box

A remote control box can be connected to the D-Sub socket on the rear and allows you to switch the Isolation on and off externally.



Modulation Input box

A modulation-box in combination with a sine wave generator allows an excitation signal to be applied to the TS-Isolation System so that the system may be used as a shaker in any direction. The modulation is applied to the isolated TS system so that external vibrations are avoided.

Different excitation directions (vertical, X, Y) can be selected by the mode switch.



Fuses

The fuses are located in the rear panel power socket. Do not attempt to change a fuse without first unplugging the power cable. Only replace a fuse with the correct type. **Never try to bypass a fuse.**

Fuses:
2x1.6A/250V slow

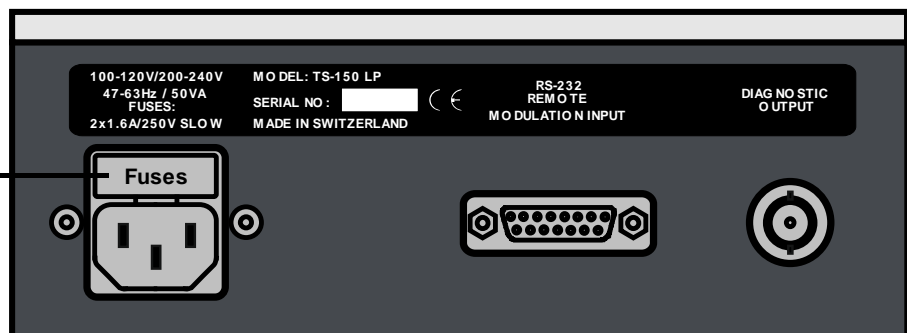

Specifications TS-150LP, TS-140LP, TS-300LP

	<i>TS-150LP</i>	<i>TS-140LP</i>	<i>TS-140LP^{±40}</i>	<i>TS-300LP</i>	<i>TS-300LP LT</i>
<i>Load capacity (Load in centre)</i>	0-150kg 0-330.7lbs	0-140kg 0-308.6lbs	60-180kg 133-396lbs	0-300kg 0-661.4lbs	0-120kg 0-264.5lbs
<i>Size</i>	400×450mm 15.7×17.7"	500×600mm 19.7×23.6"	500×600mm 19.7×23.6"	600×800mm 23.6×31.5"	600×800mm 23.6×31.5"
<i>Height</i>	78.5mm 3.1"	84mm 3.3"	84mm 3.3"	120mm 4.72"	120mm 4.72"
<i>Weight</i>	17.5kg 38.6lbs	28.5kg 62.8lbs	28.5kg 62.8lbs	53kg 116.8lbs	53kg 116.8lbs
<i>Isolation technology</i>	Highly sensitive piezoelectric sensors in combination with fast and low power consumption force-motors				
<i>Correction directions</i>	Active Isolation against all six translational and rotational vibration modes				
<i>Isolation</i>	Dynamic 0.7 Hz to 200 Hz, mainly passive at higher frequencies although for good stability the feedback is active to at least 2 kHz				
<i>Transmissibility</i>	See attached curves on page 14 above ~10 Hz transmissibility <0.01 (-40dB)				
<i>Correction Forces</i>	±8N vertical, ±4N horizontal				
<i>System Noise</i>	Less than 20ng/√Hz from 0.1-200Hz in any direction				
<i>Table Top</i>	Damped aluminium sandwich construction. Also available with tapped M6 on 25mm or ¼-20×1" UNC centres, or customized made of aluminium or ferromagnetic steel				
<i>Input Voltage</i>	90 – 120V AC, 47 – 63 Hz 200 – 240V AC, 47 – 63 Hz				
<i>Power Consumption</i>	max. 10W when isolating, max. 20W during load adjustment				
<i>Safety class</i>	1				
<i>Fuses</i>	2×1.6A/250V slow located in the power socket on the rear side of the unit				
<i>Protection class</i>	IP 20				
<i>Temperature range</i>	5° - 40°C 41°-104°F				
<i>Relative humidity</i>	10 – 90% (5° – 30°C / 41°-86°F) 10 – 60% (30° – 40°C/ 86°-104°F)				
<i>Application</i>	Indoor				
<i>Altitude</i>	up to 2000m (6500ft)				

Bottom Mounting Holes

All TS systems have **three threads on the bottom side** which allows you to screw it onto a table or bench.



Before you attach the system you have to make sure it is sitting properly on all four feet. (Adjust foot on the rear right corner). Do not tighten the screws to hard!

	A	B	C	D	E
TS-150LP	450mm 17.7"	400mm 15.7"	398mm 15.67"	348mm 13.7"	M4
TS-140LP	600mm 23.6"	500mm 19.7"	530mm 20.87"	450mm 17.72"	M5
TS-300LP TS-300LP LT	800mm 31.5"	600mm 23.6"	784mm 30.87"	584mm 22.99"	M6

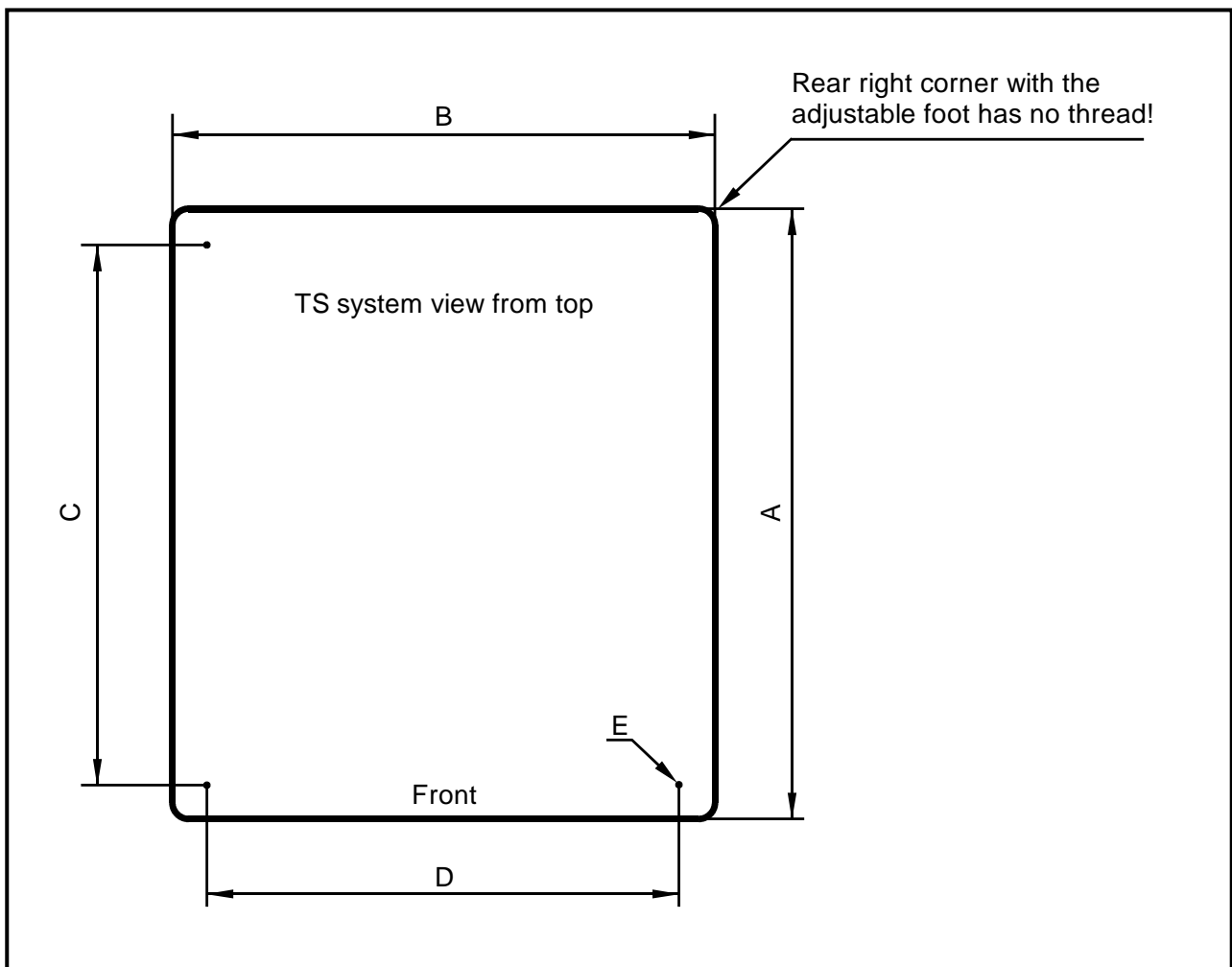

Transmissibility

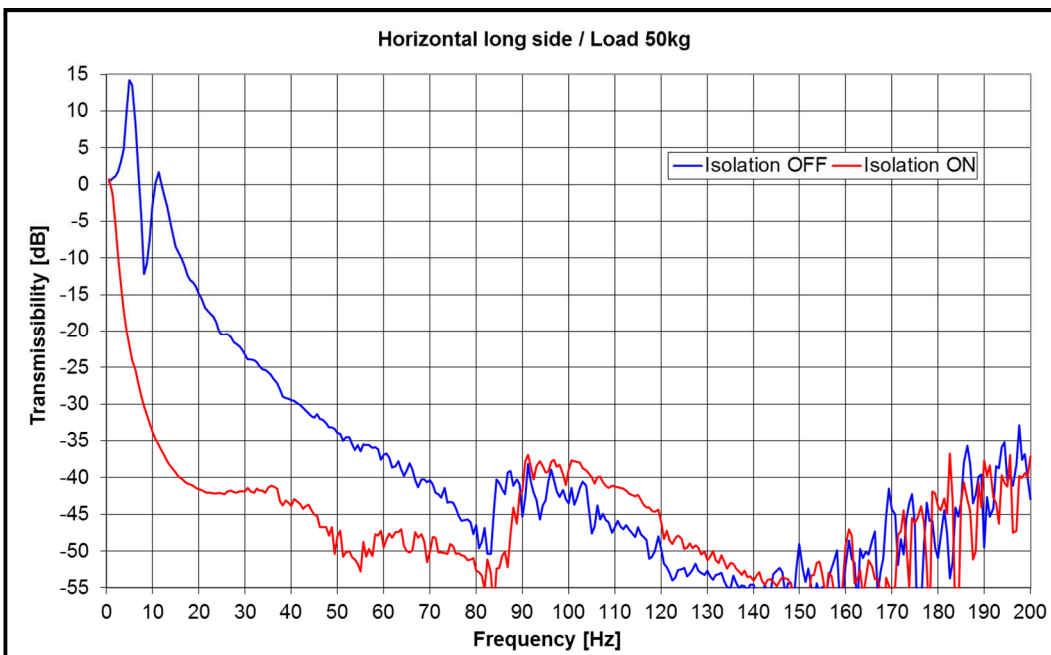
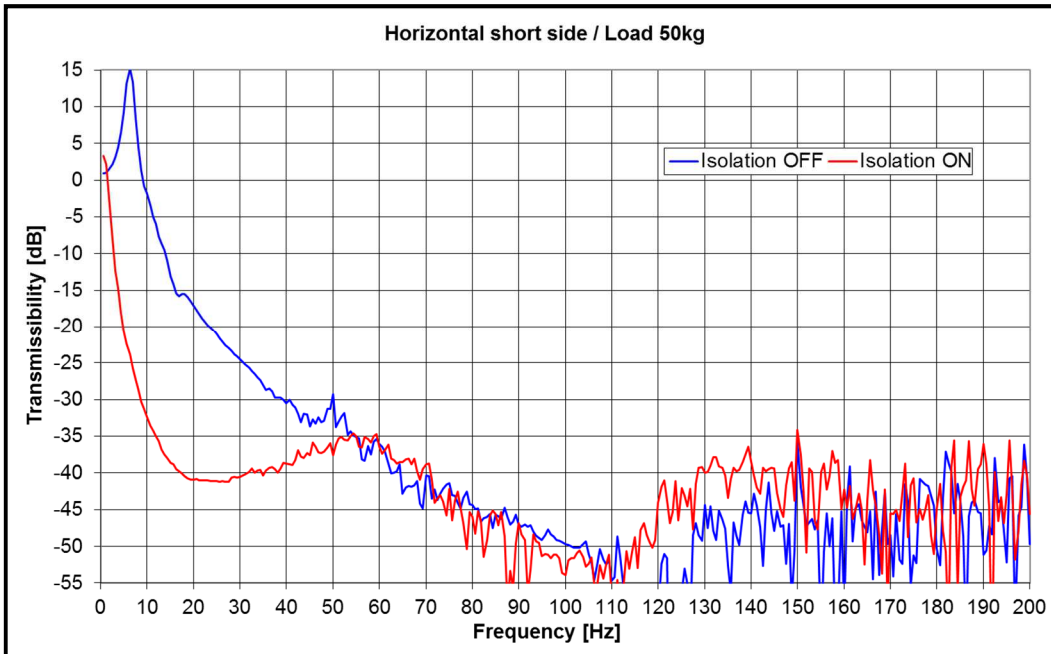
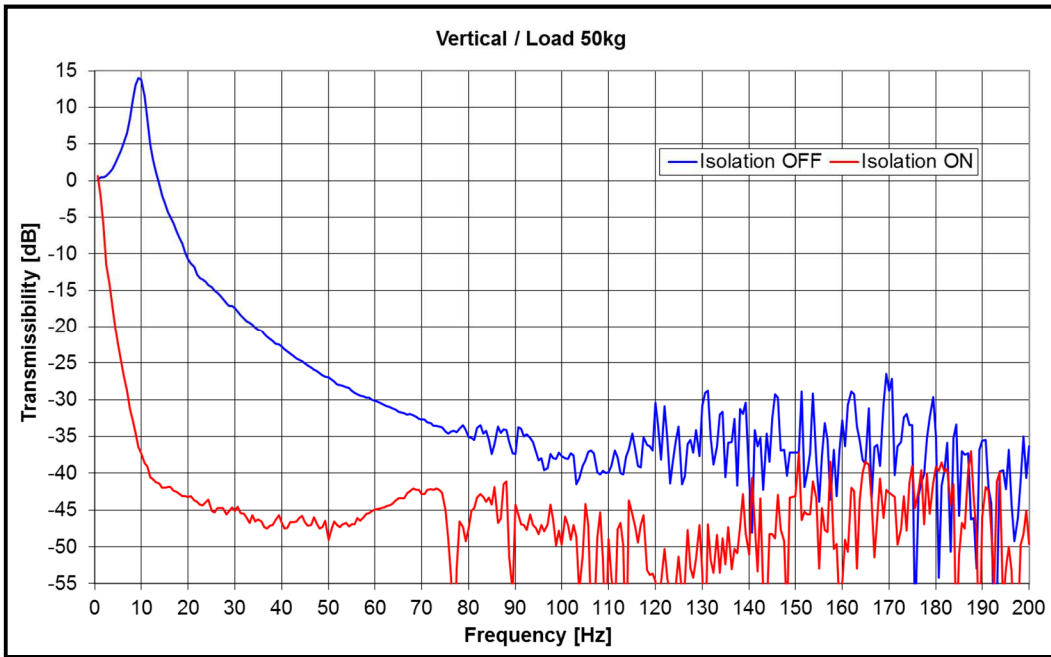

Service Order

If you suspect that a fault has developed in your isolation system, please fill in the service order form and send by fax/email to the address below. Our service department will contact you by return. If it proves to be necessary to return the system for repair, you will be issued with an **RMA number** which should then appear on all shipping documents. You also can download the service order sheet from our website: www.tablestable.com

The TableStable Ltd.
Im Grindel 6
8932 Mettmenstetten
Switzerland

Phone: +41 (0)44 776 33 66
Fax: +41 (0)44 776 33 65
E-mail: info@tablestable.com
Internet: www.tablestable.com

Sales Offices

<p>Geographical Europe, near and middle East, Africa, India:</p>		<p>Derendingerstrasse 40 72072 Tübingen Germany Phone: +49-7071-54-99 863 Fax: +49-7071-54-98-821 E-mail: hwl@hwlsscientific.com Internet: www.hwlsscientific.com</p>
<p>Americas, Australia, New Zealand:</p>		<p>23042 Alcalde Drive, Suite E Laguna Hills, Ca 92653 USA Phone: 949-363-2905 Fax: 949-340-9751 E-mail: sales@herzan.com Internet: www.herzan.com</p>
<p>Asia:</p>		<p>18/F, Yokohama Creation Square Bldg. 5-1 Sakaecho, Kanagawa-Ku Yokohama Kanagawa 221-0052 Japan Phone: +81-45-450-2211 Fax: +81-45-450-2221 E-mail: sales@herz-f.co.jp Internet: www.herz-f.co.jp</p>
<p>ASEAN countries and China (including Hong Kong)</p>		<p>83 Bukit Drive, #05-07 Singapore 587849 Phone: +65 96181 268 E-mail: enquiry@octalab.com Internet: www.octalab.com</p>